

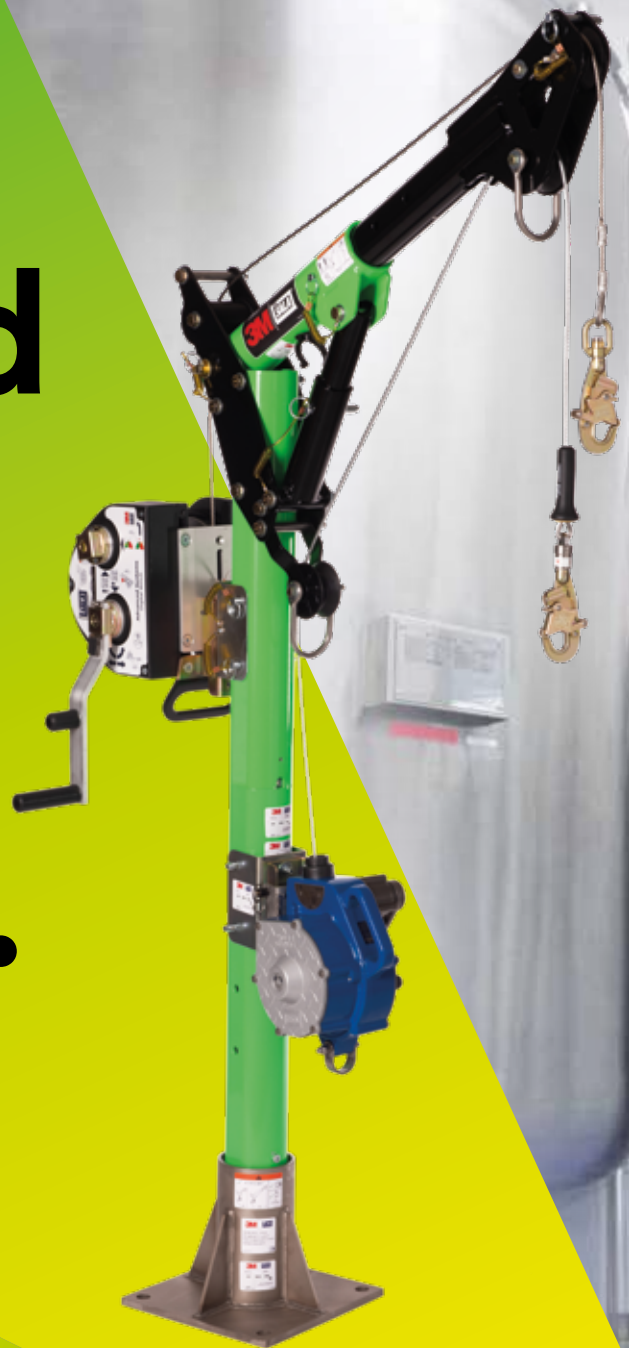

Fall Protection

# Confined Space Rescue Systems.



# Experts in confined space entry, retrieval and fall protection.

Confined spaces can be below or above ground and are found on most job sites. Each year many workers are injured or killed while performing their daily work activities in confined spaces.

Confined spaces have limited openings for entry and exit which complicates rescue/retrieval and other emergency response services. These often dangerous work environments are enclosed or partially enclosed and not designed or intended for long-term human occupancy. A restrictive confined space can represent health and safety risks to anyone who enters.

3M™ Fall Protection ISO 9001-2000 certification drives superior engineering, quality manufacturing and unparalleled customer services. Our design and engineering teams excel at finding the best way to keep workers totally safe and comfortable.

Combining experience and knowledge with state-of-the-art outdoor and indoor testing procedures, we produce some of the most technologically advanced safety equipment in the world.

# Contents.

Industry Experience	2
ABCs of fall protection	4 - 5
Davit Arm System & Components	6 - 7
Davit Arm Systems	8
Adjustable Offset Davits / Upper & Lower Masts	9
Portable & Fixed Bases	10 - 11
Counterweight Systems	12
Vehicle Hitch Mount Sleeve System	13
Pole Hoist System & Accessories	14
Tripods System	15 - 16
Portable Fall Arrest Posts	17 - 18
Digital Winches	19 - 20
Winch Brackets & Accessories	21 - 22
Personal Protective Equipment	23

## Your Partner in Safety

The highly trained professionals at 3M educate, train and provide extensive long term support in fall protection products to ensure that all aspects of your fall protection program are successful.

Choose 3M™ DBI-SALA® Products - your one-stop for the most comprehensive collection of innovative fall protection products for any confined space application!

All 3M Fall Protection's Systems and Anchor Products fully meet or exceed every key safety standard required including PPE Regulation and European Standards EN795. Our products are independently tested and certified, CE marked where allowed.



The mounting and use of the product described within this document assumes that the user has previous experience of this type of product and that it will be assembled by a competent professional according to product documentation. Before any use of this product it is recommended to complete some trials to validate the performance of the product within its expected application. All information and specification details contained within this document are inherent to this specific 3M product and would not be applied to other products or environment. Any action or usage of this product made in violation of this document is at the risk of the user. Compliance to the information and specification relative to the product contained within this document does not exempt the user from compliance with additional guidelines (safety rules, procedures). Compliance to operational requirements especially in respect to the environment and usage of tools with this product must be observed. The 3M Group (who cannot verify or control these elements) would not be held responsible for the consequences of any violation of these rules which remain external to its decision and control. Warranty conditions for products are determined with the sales contract documents and with the mandatory and applicable law, excluding any other warranty or compensation.

# ABCs of fall protection.

A typical Personal Fall Arrest System (PFAS) incorporates key components often described as the ABCs of fall protection.



## Anchorage

Anchorage are a secure point of attachment.

Anchorage connectors vary by industry, job, type of installation and structure. They must be able to hold fast under the load of a fall, working in suspension or a rescue.

# A

+



## Body support

Harnesses distribute fall forces over the upper thighs, pelvis, chest and shoulders.

They provide a connection point on the worker for the personal fall protection system.

# B

+



## Connecting devices

Products such as shock absorbing lanyards or self-retracting lifelines connect a worker's harness to the anchorage.

# C

The (A) anchorage/anchorage connector, (B) body support and (C) connecting device - when used together - form a complete system for maximum worker protection. But don't forget the other important components of a comprehensive fall protection programme: (D) descent and rescue, (E) education and (F) fall protection for tools.



### Descent and rescue

Descent and rescue devices are used to raise or lower a fallen or injured worker to safety or retrieve him from a confined space.

**D**



### Education

We offer a variety of best-in-class certified training courses for work at height and confined spaces at our state-of-the-art training centres located around the world.

We can also bring training to your workforce with our specialised demonstration vehicle providing an excellent introduction to fall protection.

**E**



### Fall protection for tools

3M™ DBI-SALA® Fall Protection for Tools helps make work environments safer and more productive by reducing dropped object incidents.

**F**

# 3M™ DBI-SALA® Davit Arm Systems.

3M™ DBI-SALA® Davit Arm Systems are designed for manhole and confined space entry/retrieval applications.

These units are constructed of lightweight materials including high-strength aluminium. The davit pivots for ease-of-rescue and has adjustment for overhead clearance restrictions. The lower base adjusts to fit most standard entries. Many other portable and fixed bases are available to suit any jobsite need.

## Standards.

Davit Arm Systems complies with:

- EN 795 'TYPE B', 2012 (Portable anchorage point).
- CEN/TS 16415:2013 'TYPE B' (Fall arrest for 2 users).
- EN1496:2006 'CLASS B' (Rescue).
- Machine Directive 2006/42/CE § 6 (Load lifting).



Fall Protection

## 3M™ DBI-SALA® Davit Arm

- Full versatility of head and arm extension regardless of the front / back mounted SRL / winch
- Meets PPE regulation with EN795 type B - 2012 certified
- 2 devices (SRL / winch) can be fixed on the davit
- 2 user rated for fall arrest
- Man and load riding certified
- Suitable for rescue with rescue winch or 3M™ DBI-SALA® Sealed-Block / 3M™ Protecta® Rebel with retrieval winch.

### A Fall Arrest Anchorage

Davits offers 4 x EN 795 type B anchor points and are **certified for fall arrest for 2 users at the same time**

- 2 anchor points for direct connection with fall arrest PPE
- 2 guided cable lifelines from a 3M™ mounted SRL.

### B One Front and One Back Cable Lifeline Guide

In addition to being a fall arrest anchorage, the 2 guided cable lifelines serve as:

- Rescue line with a mounted 3M™ DBI-SALA® rescue winch or 3M™ SRL with built-in rescue winch
- Raising / lowering line for people or load with a mounted 3M™ DBI-SALA® man and load-riding digital winch.

### C Winch and SRL Options

Winch and SRL can be mounted on the mast with appropriate bracket.

**Front or back mounting choice is possible to allow the most convenient positioning for the user,** unlike some others systems that only allow the winch and SRL to be back mounted or allowing only one fixation to the mast.

### Adjustable Reach and Height

**D** Selection of one of the 4 davit mast extension options allows the user to select the best height setting for the operating environment.

**E** Multiple pins position of the gusset arm and head allows the user to adjust the best reach and height needed for the application.

**Possibility of maximum height of anchorage point is 2.91 m, allowing use over most tanks edges and guardrails.**

### F Base Options

Fixed bases in galvanized steel or stainless steel are available to accommodate a variety of anchorage locations.

One short reach and one long reach portable 3 piece base options allow full versatility of the systems.

**Maximum external width of long reach 3 piece base is 2.61 m, allowing the surround of very large confined space openings.**

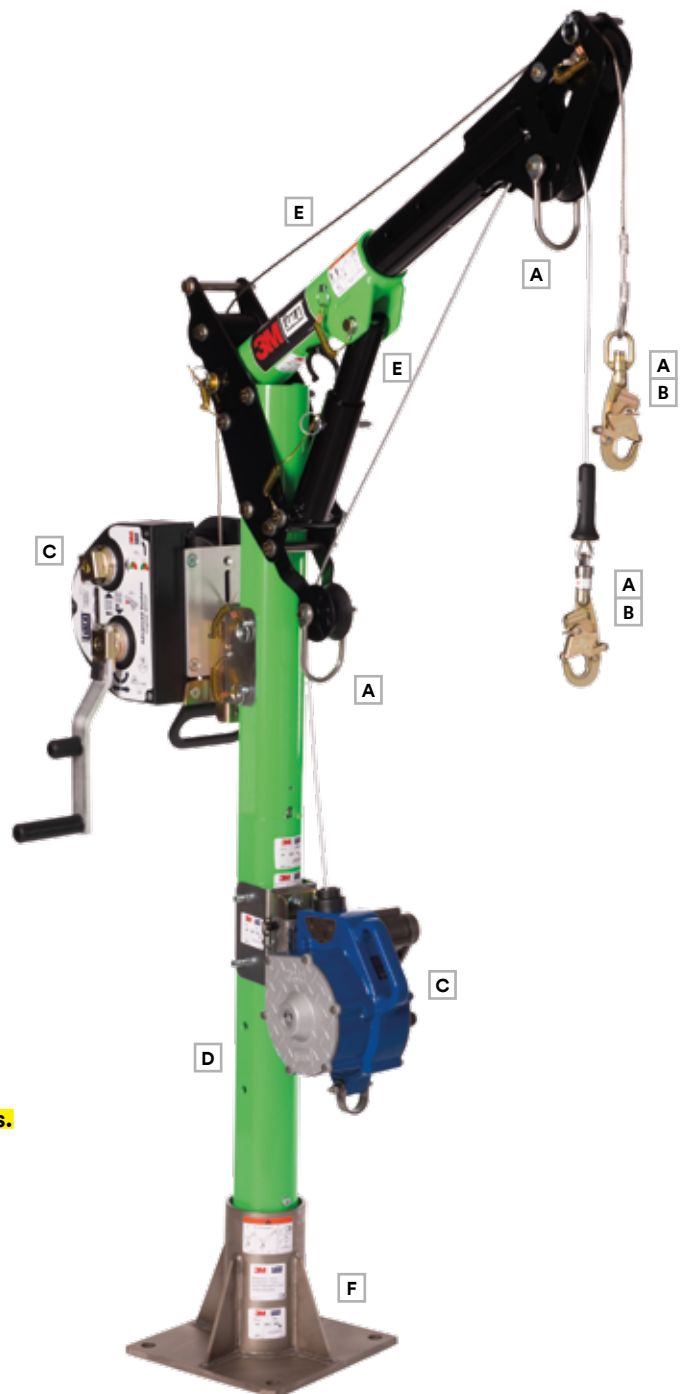

## 3M™ DBI-SALA® 5 Piece Short Reach Davit High Capacity (HC)

CE  
EN795  
TYPE B

	←-----→	kg
8000118	S	65.30

Includes Short Reach Davit Arm High Capacity (8000107), 84 cm Mast Extension (8000113) and Short Reach 3 Piece Davit High Capacity Base (8000104). Includes 1 winch mounting bracket.

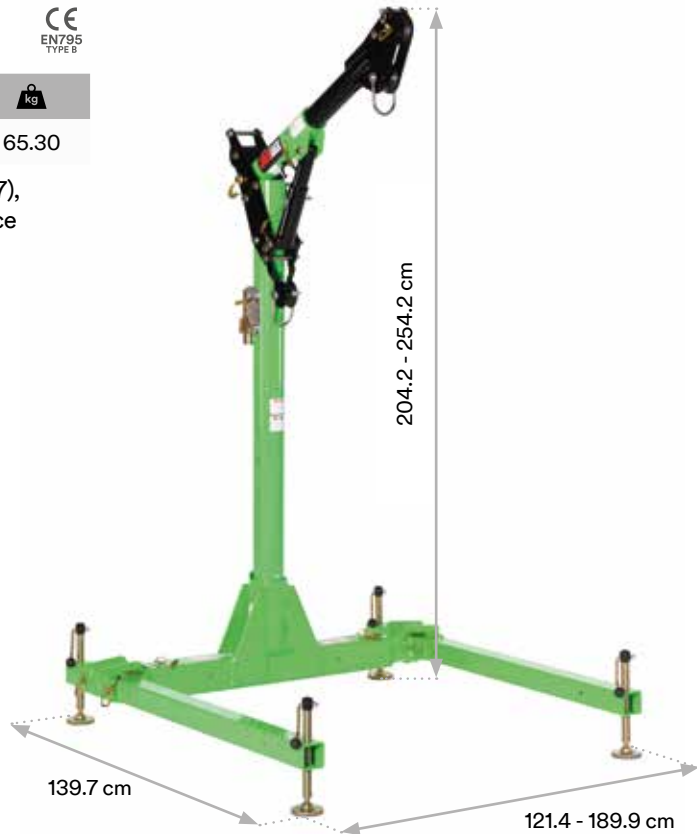

## 3M™ DBI-SALA® 5 Piece Long Reach Davit High Capacity (HC)

CE  
EN795  
TYPE B

	←-----→	kg
8000119	L	81.60

Includes Long Reach Davit Arm High Capacity (8000108), 84 cm Mast Extension (8000113) and Long Reach 3 Piece Davit High Capacity Base (8000105). Includes one winch mounting bracket.

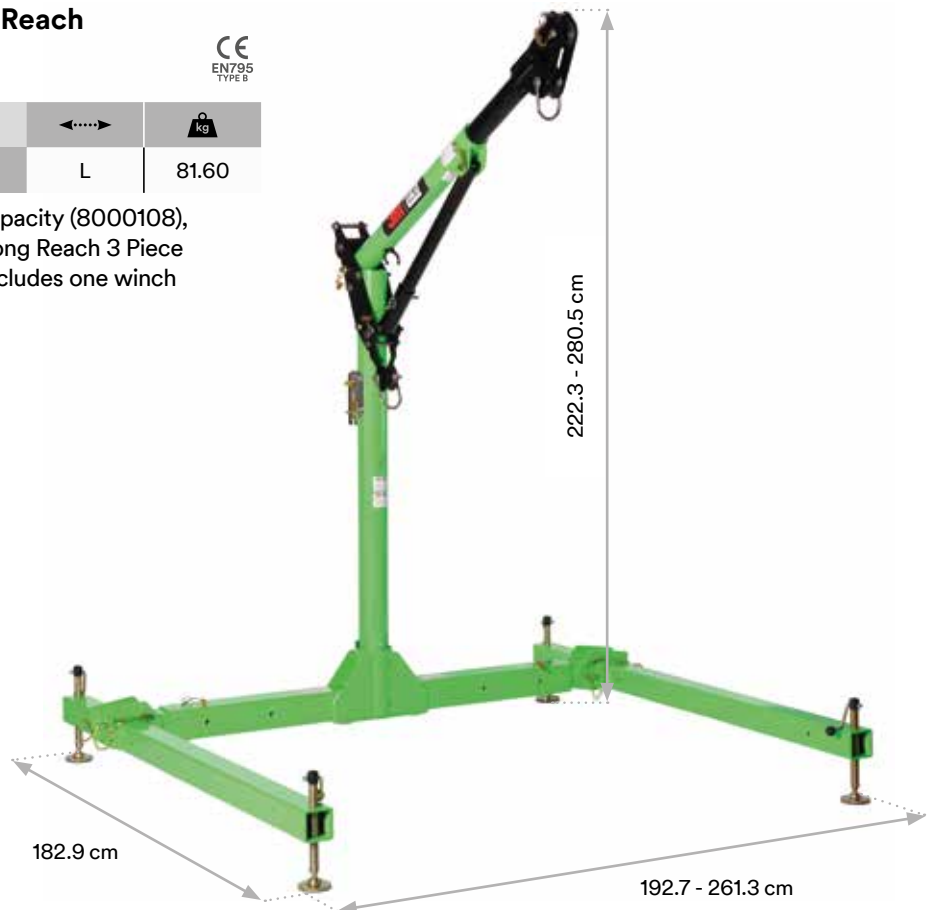



# 3M™ DBI-SALA® Adjustable Offset Davits / Upper & Lower Masts

## 3M™ DBI-SALA® Short Reach Davit Arm High Capacity (14" - 28")

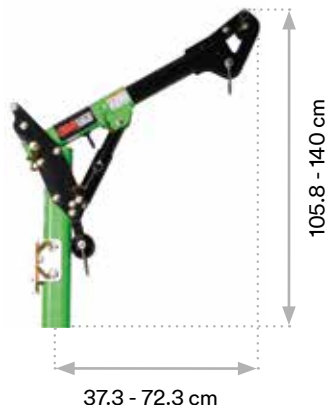

CE  
EN795  
TYPE B

	←-----→	kg
8000107	S	16.50

Includes Short Reach Offset Arm High Capacity (8000110) and Universal Lower Mast High Capacity (8000109).

## 3M™ DBI-SALA® Long Reach Davit Arm High Capacity (27" - 44")

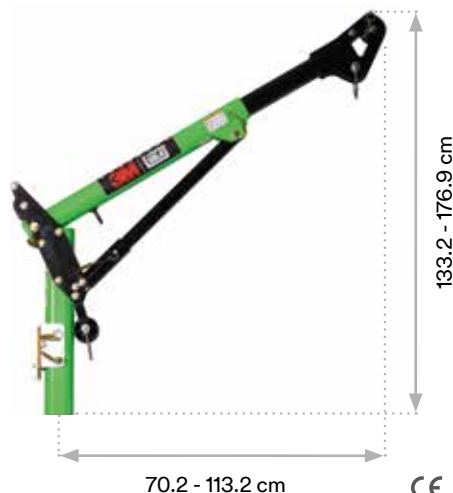

CE  
EN795  
TYPE B

	←-----→	kg
8000108	L	19.20

Includes Long Reach Offset Arm High Capacity (8000111) and Universal Lower Mast High Capacity (8000109).

## 3M™ DBI-SALA® Universal Lower Mast High Capacity



	←-----→	kg
8000109	Universal	10.10

Includes one winch mounting bracket.

## 3M™ DBI-SALA® Short Reach Offset Arm High Capacity (14" - 28")



CE  
EN795  
TYPE B

	←-----→	kg
8000110	S	6.40

## 3M™ DBI-SALA® Long Reach Offset Arm High Capacity (27" - 44")



CE  
EN795  
TYPE B

	←-----→	kg
8000111	L	9.10

## 3M™ DBI-SALA® Davit Mast Extensions High Capacity

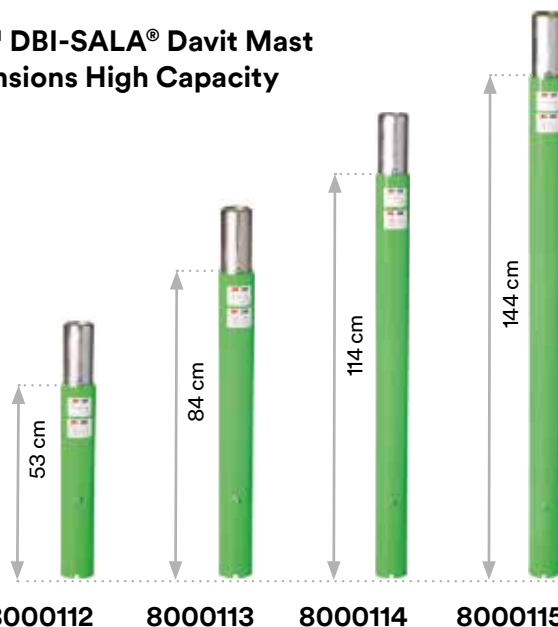

	←-----→	kg
8000112	53 cm	8.40
8000113	84 cm	10.90
8000114	114 cm	13.30
8000115	144 cm	15.70

Only one mast extension allowed for short reach or long reach davit arm.

## 3M™ DBI-SALA® 3 Piece Short Reach Davit Base High Capacity

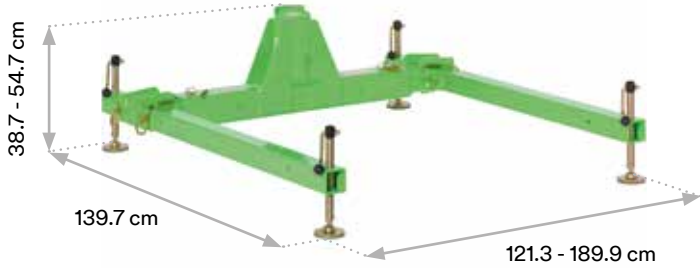

CE  
EN795  
TYPE B

	↔	⚖️
8000104	S	37.50

## 3M™ DBI-SALA® 3 Piece Long Reach Davit Base High Capacity

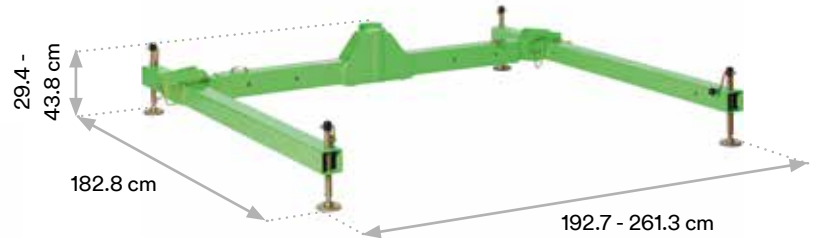

CE  
EN795  
TYPE B

	↔	⚖️
8000105	L	50.50

## 3M™ DBI-SALA® Floor Mount Base High Capacity



CE  
EN795  
TYPE A

	Description	⚖️
8000095	Galvanised steel	15.60
8000096	Stainless steel - 304	15.60

Mounts to horizontal concrete or steel structure. Comes with PVC sleeve liner.

## 3M™ DBI-SALA® Wall Mount Base High Capacity



CE  
EN795  
TYPE A

	Description	⚖️
8000101	Galvanised steel	15.70
8000102	Stainless steel - 304	15.70

Compact design creates minimum intrusion into work space. Mounts to vertical concrete or steel structures. Comes with PVC sleeve liner.

## 3M™ DBI-SALA® Flush Core Mount Base High Capacity

	Description	kg
8000089	Galvanised steel	5.40
8000090	Stainless steel - 304	5.20

Designed for slip-in installation into a Ø128.5 cm (5.06") core hole in concrete. Comes with PVC sleeve liner.



## 3M™ DBI-SALA® Flush Core Mount Base High Capacity with Top Plate



	Description	kg
8000091	Galvanised steel	12.40
8000092	Stainless steel - 304	12.20

Recessed fastener pockets allow for bolt-in installation into existing concrete. Flush mount design allows passage of traffic and eliminates trip hazards when not in use. Comes with PVC sleeve liner.



## 3M™ DBI-SALA® Deck Mount Base High Capacity



	Description	kg
8000099	Galvanised steel	14.60
8000100	Stainless steel - 304	14.50

Designed to slip into a 128.5 mm (5.06") hole in existing steel structure flooring. Comes with the necessary hardware to mount to structures with a maximum thickness of 89 mm (3.50").

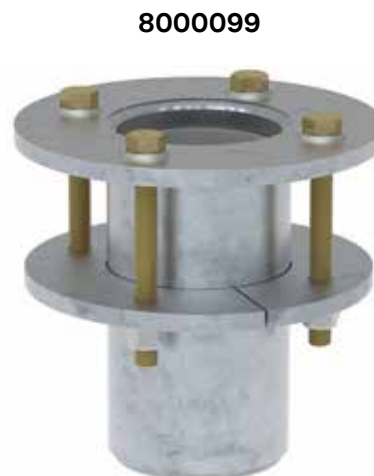

The 3M™ DBI-SALA® Counterweight System comprises a central counterweight cart with wheels connected by a bar to the davit base.

Despite its weight, the unit can be easily moved to different locations within the plant, with all components of the system being placed vertically on the cart.

Note: Individual weight plates sold separately - see below for more info.

## 3M™ DBI-SALA® Counterweight Base High Capacity with Cart



	kg
8000106	241.00

- Compatible with short and long reach davit arms
- Requires a quantity of 20 (for short reach) or 36 (for long reach) 20 kg athletic weight plates (to be ordered separately, reference 8000123)
- All base components required included
- Built-in forklift pocket and lifting rings for easy transport
- Horizontal weight arrangement is more ergonomic and safer
- Mast / davit storage included
- Swivel lock and brake wheels.

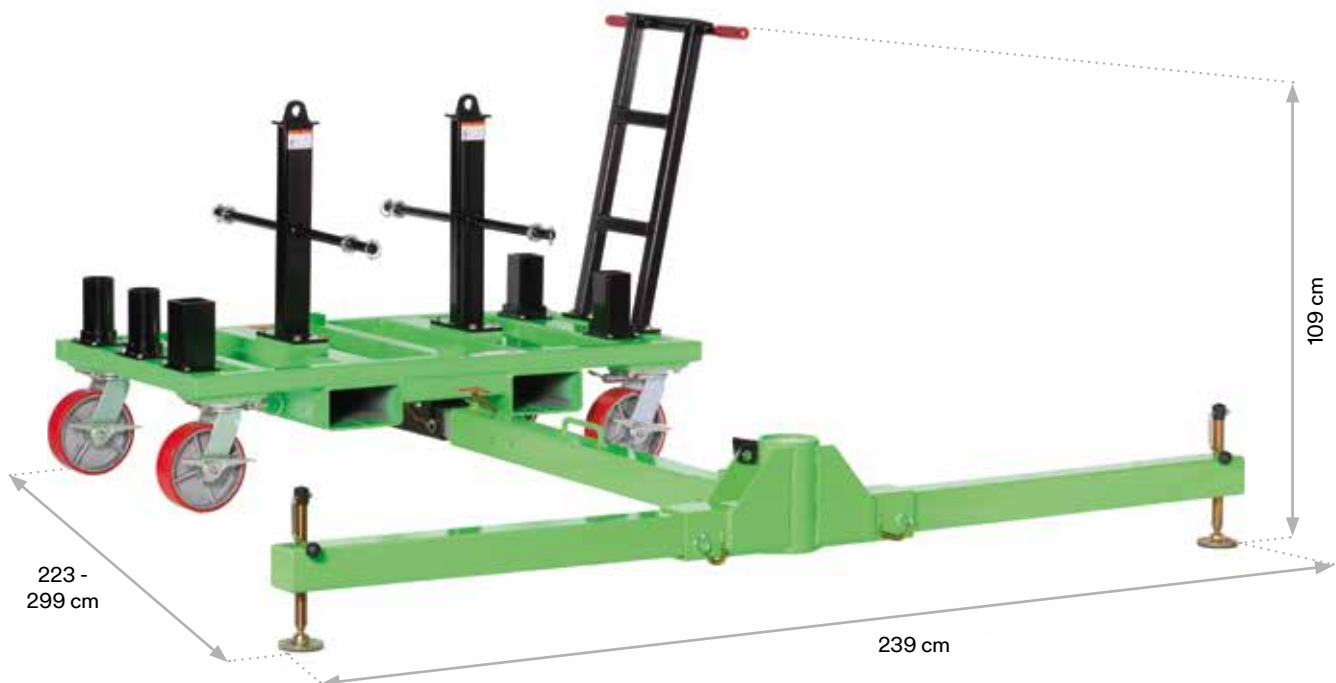

# 3M™ DBI-SALA® Vehicle Hitch Mount Sleeve System

The 3M™ DBI-SALA® Vehicle Hitch Mount Sleeve is designed to connect to an attendant vehicle with a hitch ball coupler to provide a portable anchor point for confined space entry/retrieval, rescue and fall-arrest systems.

## 3M™ DBI-SALA® Vehicle Hitch Mount Base High Capacity



8000103	40.80

- Compatible with short and long reach davit arm
- All base components required and hitch ball coupler included
- Full length adjustable
- All aluminium components for lightweight
- Adjustable screw feet
- Replaces standard supplied part for vehicles with high hitch attachment (for example: trucks).

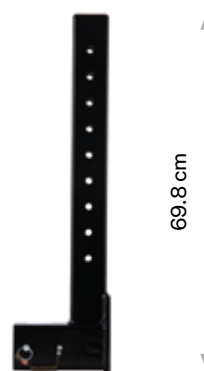
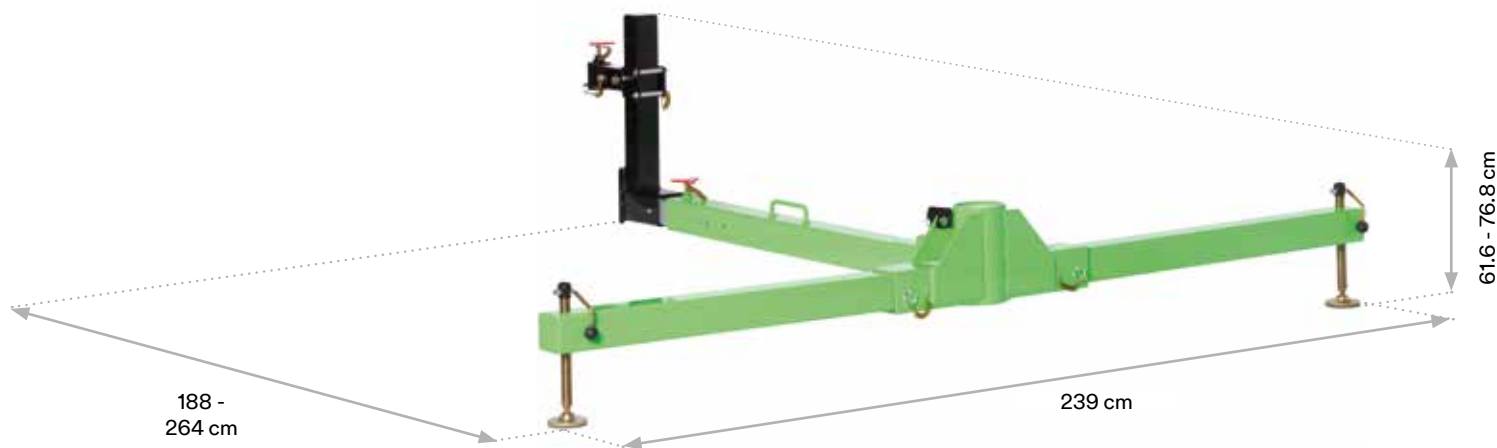

## 3M™ DBI-SALA® Extended Height Vehicle Hitch Adjustment

8000116	4.00

The 3M™ DBI-SALA® Pole Hoist attaches with a carabiner to a suitable anchor point, allowing you to work in any direction from any angle.

The 3M DBI-SALA Pole Hoist System features a swivel head that rotates 360 degrees, providing unparalleled flexibility in both vertical and horizontal confined-space entries. Overall length adjusts from either 1.2 - 2.13 m (4' - 7') or 1.8 - 3.05 m (6' - 10') for positioning attendant for working in close quarters.

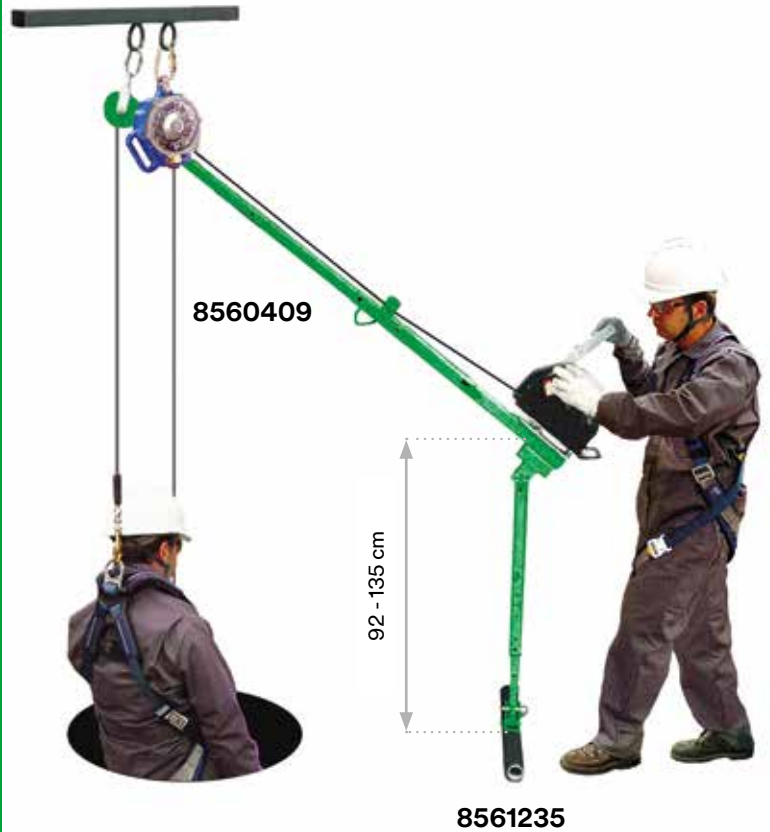

## 3M™ DBI-SALA® Pole Hoist System

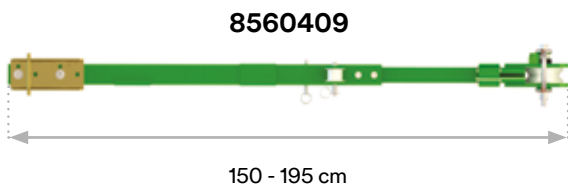

8560409	5.40 kg
---------	---------

1.2 - 2.13 m (4' - 7') Extendible Pole Hoist, swivel head & stainless steel hardware. Includes winch bracket.

## 3M™ DBI-SALA® Pole Hoist System



8560476	6.35 kg
---------	---------

1.8 - 3.05 m (6' - 10') Extendible Pole Hoist, swivel head & stainless steel hardware. Includes winch bracket.

## Accessory Options

	Description
8561235	T-bar leg assembly with stainless steel hardware (required)
8513329	Carrying Bag for 1.2 - 2.13 m (4' - 7') Pole Hoist
8513330	Carrying Bag for 1.8 - 3.05 m (6' - 10') Pole Hoist

3M™ DBI-SALA® Tripods Systems are constructed of lightweight tubular aluminium with a rugged steel head assembly.

The 3M DBI-SALA UCT-300 and UTC-1000 Tripods can be combined with up to three pulleys to accommodate a variety of winches and fall-arrest devices to meet a wide range of confined space entry/retrieval and rescue requirements.

Pulleys are mounted on top of the head assembly to provide extra overhead clearance in tight situations. Quick release pins positively locate components at all adjustment points for tool-less setup and adjustment.



## 3M™ DBI-SALA® Tripod UCT-300



8563158	21.60

Advanced UCT-300 2.13 m (7') Tripod with adjustable locking legs, safety chains, top pulley & winch bracket.  
Note: Winch not included.



## 3M™ DBI-SALA® Tripod UCT-1000



8563159	39.00

UCT-1000 aluminium 3.048 m (10') Tripod with adjustable locking legs, safety chains, top pulley & winch bracket.  
Note: Winch and SRL are not included.



### Tripod Accessories

	Description
8513329	Carrying bag with protective plastic liner for 2.13 m (7') Tripod
8513330	Carrying bag with protective plastic liner for 3.05 m (10') Tripod



8510224



8512292



### 3M™ DBI-SALA® Winch/SRL Mounting Brackets

	Description	
8510224	For UCT-300 Tripod	1.40
8512292	For UCT-1000 Tripod	2.40

Attaches to the leg tube with quick-release pins for tool-less set-up and adjustment.

### 3M™ DBI-SALA® Top Pulley Assembly for UCT 300 & 1000 Tripods

	Description	
8512293	For UCT-300 Tripod	0.73
8549768	For UCT-1000 Tripod	0.70

Pulleys are mounted on top of the head assembly to provide extra overhead clearance in tight situations.



# 3M™ DBI-SALA® Portable Fall Arrest Posts

The 3M™ DBI-SALA® Portable Fall Arrest Post is specifically designed for use on top of transformers or other types of vertical platforms with potential fall hazards.

It's compact and lightweight design of only 17.2 kg (38 lbs) makes the post very easy to transport and put in place. The system features 3 independent swivel anchor points. They can rotate 360 degrees, offering freedom of mobility for up to 3 workers with self-retracting lifelines or fixed length lanyards. The 3M DBI-SALA Portable Fall-Arrest System has 3 telescopic working heights ranging from 774 mm (30.5") 1092 mm (43"), all the way up to 1384 mm (54.5"). This decreases a worker's fall distance and increase the overall work area.

## 3M™ DBI-SALA® Portable Fall Arrest Post



1st Position  
Fully Collapsed

2nd & 3rd Positions  
Partially Extended

4th Position  
Fully Extended



	Description	kg
8566691	Portable fall arrest post	17.20

## 3M™ DBI-SALA® Portable Fall Arrest System Anchor Base with Tie-Off Anchor



	Description	kg
8567412	To be welded, bare steel	5.60
8569819	To be bolted down, zinc plated steel	19.30
8567422	To be welded, sandblasted bare steel to be painted	5.60



## 3M™ DBI-SALA® ISO Container Fall Arrest Post



	kg
8563161	12.00

Compatible with all ISO certified containers. Provides an elevated anchorage point reducing fall clearance requirements. Ensures total fall protection solution, even while working on a single container. No tools or container modification required.



# 3M™ DBI-SALA® Digital Winches.

3M™ DBI-SALA® Digital winches are rated for a maximum working load of 205 kg (450 lbs). This winch has two cranking speeds capable of retrieval/descent from 4 m/min (13 ft/min) to 9 m/min (30 ft/min).

3M DBI-SALA digital winches are available in two body sizes. All cable assemblies come with a double locking swivel snap hook with overload indicator.



## Man Rated

For raising, lowering or supporting personnel. Working load 205 kg (450 lbs). Designed specifically for confined space entry/retrieval.

## Digital Usage Indicator

The exclusive “digital usage indicator” system counts the revolutions of the drum to determine service intervals. Additional standard features include a braking system with 3 independent working pawls, centrifugal back-up brake, carrying handle and cable retainer spring.

## Compliant Hardware

Double locking swivel safety snaps standard on all cables. Sealed bearings at all contact points. All hardware is zinc plated. All components are zinc-plated steel or anodized aluminium.

## Triple Redundant Braking Mechanism

A friction brake is engaged by a minimum of 2 kg (5 lbs). Brake pad wear indicator monitors the condition of the braking mechanism, which features an inertial (centrifugal) safety back up brake.

## 3M™ DBI-SALA® Digital Winch Series 100. 2 Speed Winch with Removable Handle

	Description	Actual Length	Working Length	kg
8518560	Removable handle, galvanised steel cable	21.3 m (70')	18 m (60')	13.80
8518558	Removable handle, stainless steel cable	21.3 m (70')	18 m (60')	13.80
8518561	Removable handle, galvanised steel cable	30 m (100')	27 m (90')	14.70
8518559	Removable handle, stainless steel lifeline	30 m (100')	27 m (90')	14.70

Includes a removable aluminium crank handle to utilise both the 9:1 and 4:1 drives. These two drives offer the capability of retrieval/descent at average speeds from 4 m/min (13 ft/min) up to 9 m/min (30 ft/min).

## 3M™ DBI-SALA® Digital Winch Series 100 - Power Drive. 2 Speed Winch with 9:1 Power Drive & 4:1 Removable Handle

	Description	Actual Length	Working Length	kg
8518567	Power drive & removable handle, galvanised steel cable	21.3 m (70')	18 m (60')	13.80
8518565	Power drive & removable handle, stainless steel cable	21.3 m (70')	18 m (60')	13.80
8518568	Power drive & removable handle, galvanised steel cable	30 m (100')	27 m (90')	14.70
8518566	Power drive & removable handle, stainless steel cable	30 m (100')	27 m (90')	14.70

Features a power drive hub on the 9:1 drive. An overload protection clutch installs between this power drive hub and an electric or pneumatic drill to eliminate overloading the winch during retrieval. This clutch also protects the winch operator and the retrieved worker from injury. The clutch is installed and removed without the use of tools when switching to the 4:1 manual crank option in emergencies. (8512936: Overload Protection Clutch sold separately.)

## 3M™ DBI-SALA® Digital Winch Series 200. 2 Speed Winch with Removable Handle

	Description	Actual Length	Working Length	kg
8518581	Removable handle, galvanised steel cable	45.7 m (150')	42 m (140')	18.40
8518579	Removable handle, stainless steel cable	45.7 m (150')	42 m (140')	18.40
8518582	Removable handle, galvanised steel cable	61 m (200')	58 m (190')	19.50
8518580	Removable handle, stainless steel cable	61 m (200')	58 m (190')	19.50

Includes a removable aluminium crank handle to utilise both the 9:1 and 4:1 drives. These two drives offer the capability of retrieval/descent at average speeds from 4 m/min (13 ft/min) up to 9 m/min (30 ft/min).

## 3M™ DBI-SALA® Digital Winch Series 200 - Power Drive. 2 Speed Winch with 9:1 Power Drive & 4:1 Removable Handle

	Description	Actual Length	Working Length	kg
8518588	Power drive & removable handle, galvanised steel cable	45.7 m (150')	42 m (140')	18.40
8518586	Power drive & removable handle, stainless steel cable	45.7 m (150')	42 m (140')	18.40
8518589	Power drive & removable handle, galvanised steel cable	61 m (200')	58 m (190')	19.50
8518587	Power drive & removable handle, stainless steel cable	61 m (200')	58 m (190')	19.50

Features a power drive hub on the 9:1 drive. An overload protection clutch installs between this power drive hub and an electric or pneumatic drill to eliminate overloading the winch during retrieval. This clutch also protects the winch operator and the retrieved worker from injury. The clutch is installed and removed without the use of tools when switching to the 4:1 manual crank option in emergencies. (8512936: Overload Protection Clutch sold separately.)

## 3M™ DBI-SALA® Winch Mounting Bracket for Davit Arm High Capacity



	kg
<b>8000117</b>	2.00

Quick release mounting bracket with flat back adapter for winch / SRL for 3M DBI-SALA Davit Arm High Capacity.

## 3M™ DBI-SALA® Sealed-Blok™ Retrieval SRL Mounting Bracket



	↔	kg
<b>3401025</b>	For 9 m, 15 m and 25 m SRL	0.70

Attaches to 3M™ DBI-SALA® Sealed-Blok™ SRL models, supplied with mounting bolts, mates with 8000117.

## 3M™ DBI-SALA® Rebel Retrieval SRL Mounting Bracket



	↔	kg
<b>3590499</b>	For 15 m SRL	0.70

Attaches to 3M™ PROTECTA® Rebel™ Retrieval SRL model, supplied with mounting bolts, mates with 8000117.

## 3M™ DBI-SALA® Overload Clutch for Power Drive Digital Winch



	kg
<b>8512936</b>	0.68

Features a maximum working load of 205 kg (450 lbs.). Use with cordless drill 0-300 RPM, 45 N.m torque minimum.

## 3M™ DBI-SALA® Carrying Bag for Digital Winch



	kg
<b>8517567</b>	1.00

For digital winch, c/w Carrying Handle.

## 3M™ DBI-SALA® Cap for Bases High Capacity



	Description	kg
8000121	Acetal plastic	0.70

Allows to close and seal fixed base openings.  
Non protruding surface. Easy to lift out with foldable ring.

## 3M™ DBI-SALA® Base Adaptor 3" / 4"



8000124



8000134

	Description	kg
8000124	Adaptor allows use of <b>ONLY SHORT REACH</b> Davit High Capacity with old 3" <b>FIXED</b> bases.	10.70
8000134	Adaptor allows use of short and long reach davit of old 3" design with <b>FIXED</b> bases High Capacity.	1.40

## 3M™ DBI-SALA® Carrying Bag for Davit High Capacity



	kg
8513329	1.77

Carrying bag for any mast extension High Capacity and short or long reach davit High Capacity.

# 3M™ Personal Protective Equipment (PPE).

3M is passionate about protecting the health and safety of workers in all types of industries and workforce environments.

This passion helps drive us to continue to innovate across technologies, disciplines, and industries to help keep your workers safe and protected.

We strive to deliver comfortable, well-designed personal protective equipment (PPE) that offers your workers the most effective protection available. You can buy 3M Safety PPE, confident in the knowledge that 3M is working hard to provide products that your employees will feel good about wearing.

For more information visit: [www.3M.com](http://www.3M.com)

**Eyewear**



**Hearing**



**Fall Protection**



**Scotchlite™**



**Respiratory**



**Protective apparel**



**Welding**



**Head & Face**



**3M Belgium BVBA / SPRL**

Hermeslaan 7  
1831 Diegem  
België / Belgique  
E-mail: [3Msafety.be@mmm.com](mailto:3Msafety.be@mmm.com)  
[www.3Msafety.be](http://www.3Msafety.be)

**3M Danmark**

Hannemanns Allé 53  
2300 København S  
Danmark  
E-mail: [3Msikkerhed@mmm.com](mailto:3Msikkerhed@mmm.com)  
[www.3Msikkerhed.dk](http://www.3Msikkerhed.dk)

**3M Deutschland GmbH**

Carl-Schurz-Straße 1  
D - 41453 Neuss  
Deutschland  
E-mail: [arbeitsschutz.de@mmm.com](mailto:arbeitsschutz.de@mmm.com)  
[www.3Marbeitsschutz.de](http://www.3Marbeitsschutz.de)

**3M Espana, S.A.**

Juan Ignacio Luca de Tena, 19-25  
28027 Madrid  
Espana  
E-mail: [ohes.es@3M.com](mailto:ohes.es@3M.com)  
[www.3M.com/es/seguridad](http://www.3M.com/es/seguridad)

**3M France**

Boulevard de l'Oise  
95006 Cergy Pontoise Cedex  
France  
[www.3M.com/fr/secure](http://www.3M.com/fr/secure)

**3M Greece**

20 Kifissias Ave.  
151 25 Maroussi  
Athens, Greece  
[www.3M.com/gr/occsafety](http://www.3M.com/gr/occsafety)

**3M Ireland Limited**

The Iveagh Building  
The Park, Carrickmines  
Dublin 18  
Ireland  
E-mail: [ohes.helpline.uk@mmm.com](mailto:ohes.helpline.uk@mmm.com)  
[www.3M.co.uk/safety](http://www.3M.co.uk/safety)

**3M Italia srl**

Via Norberto Bobbio, 21  
20096 Pioltello MI  
Italia  
E-mail: [3Msicurezza@mmm.com](mailto:3Msicurezza@mmm.com)  
[www.3Msicurezza.it](http://www.3Msicurezza.it)

**3M Nederland B.V.**

Molengraaffsingel 29  
2629 JD Delft  
Nederland  
E-mail: [3Msafety.nl@mmm.com](mailto:3Msafety.nl@mmm.com)  
[www.3Msafety.nl](http://www.3Msafety.nl)

**3M Norge A/S**

Postboks 100, 2026 Skjetten  
Norge  
E-mail: [kundeservice@mmm.com](mailto:kundeservice@mmm.com)  
[www.3M.no/vern](http://www.3M.no/vern)

**3M Österreich GmbH**

Kranichberggasse 4  
1120 Wien  
Österreich  
[www.3M.com/at/arbeitsschutz](http://www.3M.com/at/arbeitsschutz)

**3M Portugal**

Rua do Conde Redondo, 98  
1169-009 Lisboa  
Portugal  
[www.3M.com/pt/seguranca](http://www.3M.com/pt/seguranca)

**3M Suisse S.a r.l. / Schweiz GmbH**

Eggstrasse 93  
8803 Rüschiikon  
Suisse / Schweiz  
[www.3M.com/ch/safety](http://www.3M.com/ch/safety)

**Suomen 3M Oy**

Keilaranta 6  
02150 Espoo  
Suomi  
[www.3M.fi/suojaimet](http://www.3M.fi/suojaimet)

**3M Svenska AB**

191 89 Sollentuna  
Sverige  
E-mail: [kundeservice@mmm.com](mailto:kundeservice@mmm.com)  
[www.3M.se/personskydd](http://www.3M.se/personskydd)

**3M United Kingdom PLC**

3M Centre  
Cain Road  
Bracknell  
RG12 8HT  
United Kingdom  
E-mail: [ohes.helpline.uk@mmm.com](mailto:ohes.helpline.uk@mmm.com)  
[www.3M.co.uk/safety](http://www.3M.co.uk/safety)

**3M Fall Protection**

**Capital Safety (Northern Europe) Limited**  
3M Centre, Cain Road  
Bracknell, Berkshire, RG12 8HT, UK

**Capital Safety Group (EMEA)**  
Le Broc Center, Bâtiment A, Z.1. 1re Avenue - BP15  
06511 Carros Le Broc, Cedex, FRANCE

Phone 00 800 999 55500 Email [informationfallprotection@mmm.com](mailto:informationfallprotection@mmm.com) Web [3M.com/FallProtection](http://3M.com/FallProtection)

3M, Protecta, DBI-SALA, Sealed-Blok and Salalift are trademarks of 3M Company.

Registered address: 3M Centre, Cain Road, Bracknell, Berkshire, RG12 8HT. Registered in England and Wales No. 1918922.

Please recycle.  
Printed in the U.K.  
©3M 2018.  
All rights reserved.